



Original operating manual

ES 100 M1 Classic

**Read carefully before initial
operation!**

Version: 06/2019, V2.2



Technische Produkte GmbH
A-3753 Dallen 15
Tel.:+43(0)2913/8001 Fax:+43(0)2913/8002
office@apv.at www.apv.at

Bezeichnung:
Modell:
Prod.Nr.:
Gewicht:
Baujahr:



Order no.: 00601-3-507

It may NOT

seem inconvenient and unnecessary to read and observe the operating instructions. It is not enough to hear and see from others that an implement is good, and then to buy it and believe that everything takes care of itself. The person concerned would then not only cause damage to himself, but also make the mistake of assuming that the cause of any problems is due to the implement, instead of himself. To ensure success, one has to go into the spirit of things, and instruct oneself about the purpose of all equipment on the implement and gain experience with its handling. Only then can one be satisfied both with the implement and oneself. These operating instructions aim to achieve this.

Leipzig-Plagwitz 1872

Table of contents

1	EC Declaration of Conformity	4
2	Identification of the implement	5
3	Service	5
4	Warranty	6
5	Accident prevention and safety instructions	6
5.1	Intended use	6
5.2	General safety-related instructions and accident prevention regulations	7
5.3	Mounted implements	8
5.4	Maintenance	9
6	Safety signs	10
7	Technical data	11
8	Basic information	12
8.1	Layout and mode of operation	12
8.2	Mounting on the tractor	12
8.3	Mounting on an implement	12
8.4	Attachment of the control box	13
8.5	Electrical connections	13
8.6	Control box	14
8.7	Regulation of the seed rate	15
8.8	Calibration test	15
8.9	Emptying the hopper	16
8.10	Removing the hopper	16
9	Settings	17
9.1	Spreading width	17
9.2	Agitator	17
9.3	Spreading disc, lateral distribution, throwing vanes	18
9.4	Deflectors (guide plate)	18
10	Setting charts	19
11	Error messages	24
12	Maintenance and care	25
12.1	General information	25
13	Storage and disposal	25
14	Accessories	26
14.1	Cable extension 5 m (4-pin)	26
14.2	Pick-up mounting bracket	26
14.3	Quad (ATV) bracket	26
14.4	Height-adjustable quad bracket	27
14.5	Precision dispersion plate	27
14.6	Calibration bag	27
15	My idea	28
16	Index	29

1 EC Declaration of Conformity

In compliance with Directive 2006/42/EC

The manufacturer APV - Technische Produkte GmbH,
Dallein 15, AT-3753 Hötzelsdorf hereby declares that the product

single disc spreader "ES 100 M1 Classic" with digital and speed-controlled module,

Implement type designation / serial no. (see handover declaration and title page)

to which this declaration of conformity refers, complies with the relevant basic safety and health requirements of EC Directive 2006/42/EC as well as the requirements of other relevant EC Directives.

2004/108/EC EMC Directive
2006/42/EC Directive

If applicable: number / title / current version of the other EC Directives

For proper implementation of the safety and health requirements mentioned in the EC Directives, the following standards and / or technical specifications were taken into account:

EN 14018 Agricultural and forestry machinery – Seed drills – Safety
EN 14982 Agricultural and forestry machinery — Electromagnetic compatibility
EN 349 Safety of machinery – Minimum gaps to avoid crushing of parts of the human body
EN 60204-1 Safety of machinery – Electrical equipment
EN 953 Safety of machinery – Guards
ISO 12100 Safety of machinery; General principles for design; Risk assessment and risk reduction
ISO 13857 Safety of machinery; Safety distances

If applicable: number / title / current version

Your CE contact person at APV is Mr. Jürgen Schöls.
He can be reached at the telephone number +43(0)2913-8001.

Dallein, 06/2019
City, Date



Signature

Ing. Jürgen Schöls
Management

2 Identification of the implement

Clear identification

The spreader can be clearly identified by the following information on the type plate:

- Designation
- Model
- Production number

Position of the type plate

The type plate is located on the steel rack, on the right side above the safety bar.

Figure with the type plate

The image shows the layout of the type plate:



The data on the type plate have the following meaning:

No.	Meaning
1	Designation
2	Model
3	Production number
4	Weight
5	Year of manufacture

Fig.: 1

3 Service

Please contact our service address in the following cases:

- If you still have questions regarding the handling of the spreader despite the information provided in this operating manual
- For spare parts orders
- To order maintenance and repair work

APV - Technische Produkte GmbH
 HEADQUARTERS
 Dallein 15
 A-3753 Hötzelsdorf
 AUSTRIA

Telephone: +43 (0) 2913 8001
 Fax: +43 (0) 2913 8002
 Email: service@apv.at
 Web: www.apv.at

4 Warranty

Please check the implement for any transport damage immediately upon receipt. Later claims regarding transport damage can no longer be considered.

We provide a one-year factory warranty as of the date of delivery (your invoice or the delivery slip serve as a warranty certificate).

This warranty is applicable for cases of material or construction faults and does not include parts that are damaged by normal or excessive wear.

The warranty expires

- if damage is caused by external forces.
- in cases of operating errors.
- if the prescribed requirements are not met.
- if the implement is modified, expanded or equipped with third-party spare parts without our permission.
- if the implement is cleaned with water.
- if the spreader is used for snow and ice removal.

5 Accident prevention and safety instructions

This chapter contains general rules of conduct for the intended use of the implement and safety-related information that should always be observed for your personal safety.

The general accident prevention regulations of the respective countries must be observed.

The implement may only be used by persons who are informed of the hazards.

5.1 Intended use

- The single disc spreader is used to spread agricultural seed. It is designed solely for normal use in agricultural operations (intended use).
- Any other use is considered to be non-intended. The manufacturer is not liable for any resulting damage, the operator alone bears the associated risk.
- Intended use also includes compliance with the conditions for operation, maintenance, and repairs prescribed by the manufacturer.
- The implement may only be used, maintained and repaired by persons who have relevant experience and were instructed on the risks. The safety instructions must also be handed over to other users.
- The single disc spreader may not be used in the rain or in a thunderstorm.
- The applicable accident prevention regulations as well as the other generally safety-related, occupational health and road traffic regulations must also be observed.
- The manufacturer is not liable for any damage resulting from unauthorised modifications and the use of components and auxiliary parts.

5.2 General safety-related instructions and accident prevention regulations

- Check the implement and the tractor for road and operational safety before every use!
- The implements must be checked regularly by the operator (before every use) for any fractures and cracks, chafe marks, leaks, loose bolts and connections, vibrations, unusual sounds, and to ensure they function correctly.
- Observe the generally applicable safety and accident prevention regulations!
- The warning and information signs applied to the implement provide important instructions for safe operation, observe them for the sake of your own safety!
- Observe the respective regulations when using public roads!
- Before starting work, get to know all of the equipment and operating elements as well as their functions. It is too late to do so during operation!
- The view on the mounted single disc spreader and the hazardous movement area must be clear to check the procedure.
- The user should wear close-fitting clothing. Avoid wearing loose clothes!
- Hearing protection should be used, if necessary.
- Keep the implements clean to reduce the risk of fire!
- Check the surrounding area before starting up and operating the implement! (Children!) Ensure sufficient visibility!
- It is not allowed to carry passengers on the implement during operation and transport!
- The implement must be coupled according to the instructions and only onto the specified devices!
- The instructions concerning assembly as well as the requirements concerning the tractor as specified in the operating manual are to be observed.
- Special care must be taken when coupling and uncoupling implement to and from the tractor!
- During assembly, the operator must ensure that the requirements for the tractor specified in the operating instructions are met and that the connections specified in the operating instructions are made correctly.
- When mounting the single disc spreader, the operator must ensure that there is a metallic connection made to the tractor.
- Always attach ballast weights at the intended attachment points according to the specifications!
- Observe the permissible axle load, total weight and transport dimensions!
- Transport equipment, e.g. lighting, warning signs and any protective equipment, must be checked and mounted!
- Triggers for fast couplers must be hanging loosely and must not trigger themselves when lowered.
- Never leave the driver's platform while driving!
- The driving behaviour, steering and braking capacity are also affected by mounted or towed implements and ballast weights. For this reason, always ensure sufficient steering and braking capacity!
- When driving in curves, take account of the wide radius and/or the centrifugal mass of the implement!
- The implement may only be operated when all of the protective devices are installed and in safety position!

- When performing the work steps, the tractor's speed must be maintained as specified in the operating instructions. This can be between 1 and 20 km/h depending on the seed.
- The operator must ensure that no one is in the vicinity of the single disc spreader when it is being moved by the tractor's hydraulic system. Visual check by the driver. The operator must ensure that the single disc spreader cannot lower when driving on the roads (shut-off valve on the tractor's hydraulic system or similar).
- No other persons may be in the hazard area of the single disc spreader. Visual check by the driver!
- It is forbidden to stand in the working area of the implement!
- Do not stand near rotating and swivelling parts of the implement!
- Hydraulic folding frames may only be actuated when nobody is standing in the swivelling range.
- There are pinch and shear points on externally powered (e.g. hydraulic) parts!
- On implements with manual folding, always ensure that the implement is stable!
- For implements that are driven rapidly with soil-driven tools: Danger after lifting due to the still rotating centrifugal mass! Only approach the implement when it has come to a standstill!
- Before exiting the tractor, lower the implement onto the ground, switch off the motor and remove the ignition key!
- Standing between the tractor and the implement is forbidden unless the vehicle is secured against rolling away using the parking brake and/or with wheel chocks!
- Folded frames and lifting devices must be locked in transport position!
- Packer catch arms must be swivelled in and locked before road transport!
- Lock the track markers in transport position!
- When filling the hopper with slug pellets or similar toxic agents, only fill as much as is needed in the near future. Protective clothing, safety gloves, and face and eye protection must be worn during the filling procedure.
- Observe the warning information provided by the manufacturer on the packaging. The seed grains used in your spreader can be toxic!
- Always keep hands, clothing etc. away from rotating parts!
- Keep your distance when the implement is switched on!
- Never look into the spreading cone!
- Product remains should be returned to the original packaging. Residues must not be released into the environment.
- Authorised crop protection products are not known to have negative effects on the materials of the implement.
- Maintenance, repair, and cleaning work as well as the elimination of malfunctions should always be performed when the drive is switched off and the motor is at a standstill!

5.3 Mounted implements

- Before mounting and dismounting implements on the three-point linkage, move the operating devices into the position that excludes unintentional lifting or lowering!
- For three-point mounting, the mounting categories of the tractor and the implement must match or be adapted!

- There is a risk of injury due to crushing and shearing points in the area of the three-point linkage!
- Do not stand between the tractor and the implement when actuating the external controls for the three-point mounting!
- When the implement is in transport position, always ensure that the tractor three-point linkage is sufficiently locked to the sides!
- When driving on roads with the implement lifted, the operating lever must be locked against lowering!

5.4 Maintenance

- Maintenance, repair, and cleaning work as well as the elimination of malfunctions should always be performed when the drive is switched off and the motor is at a standstill! – Remove the ignition key! – Switch off the implement!
- Check the nuts and bolts regularly for tight fit and retighten if necessary!
- When performing maintenance on the lifted implement, always ensure safety through suitable support elements!
- When changing work tools with sharp edges, always use suitable tools and gloves!
- Properly dispose of oils, grease and filters!
- Always cut the power supply when working on the electrical system!
- When performing electrical welding work on the tractor and mounted implement, disconnect the cable on the generator and the battery!
- Spare parts must at least comply with the technical requirements specified by the implement manufacturer! This is ensured with original parts!
- Do not clean the implement with water. It is recommended to clean the implement with compressed air. While doing this, personal protective equipment should be worn if necessary.
- Cleaning must be carried with the implement lowered, shut down and secured to prevent it being switched on again.
- The implements must be checked regularly by the operator (before every use) for any fractures and cracks, leaks, chafe marks, loose bolts and connections, vibrations and to ensure they function correctly. The implements should be cleaned regularly using compressed air. Maintenance and cleaning work must be carried out with the implement lowered, shut down and secured to prevent it being switched on again. Working under the implement is forbidden.

6 Safety signs

Observe this sticker on the implement! It informs you of special dangers!



Read and observe the operating manual before operating the implement!



Operating errors can lead to serious injuries!



Danger due to thrown parts; observe the safety distance!



Risk of injury due to moving parts. Switch off the implement and disconnect the power supply when handling!

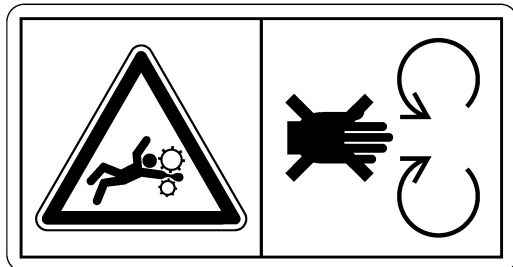

Maintain a safe distance from rotating implement parts!



Hot surface!
Do not touch!

7 Technical data

Designation:	ES 100 M1 Classic
Hopper content:	105 litres
Weight:	29 kg
Dimensions (H x W x D):	900 x 520 x 600 mm
Max. spreading width:	24 m
Recommended working width:	20 m
Power supply:	12 V, 25 A
Motor data (output):	170 watt
Power consumption of the motor:	25 amps when starting, 14 amps during normal operation
Speed range max.:	2600-3000 rpm
Mount category:	Cat. II

Hole pattern on the counter plate:

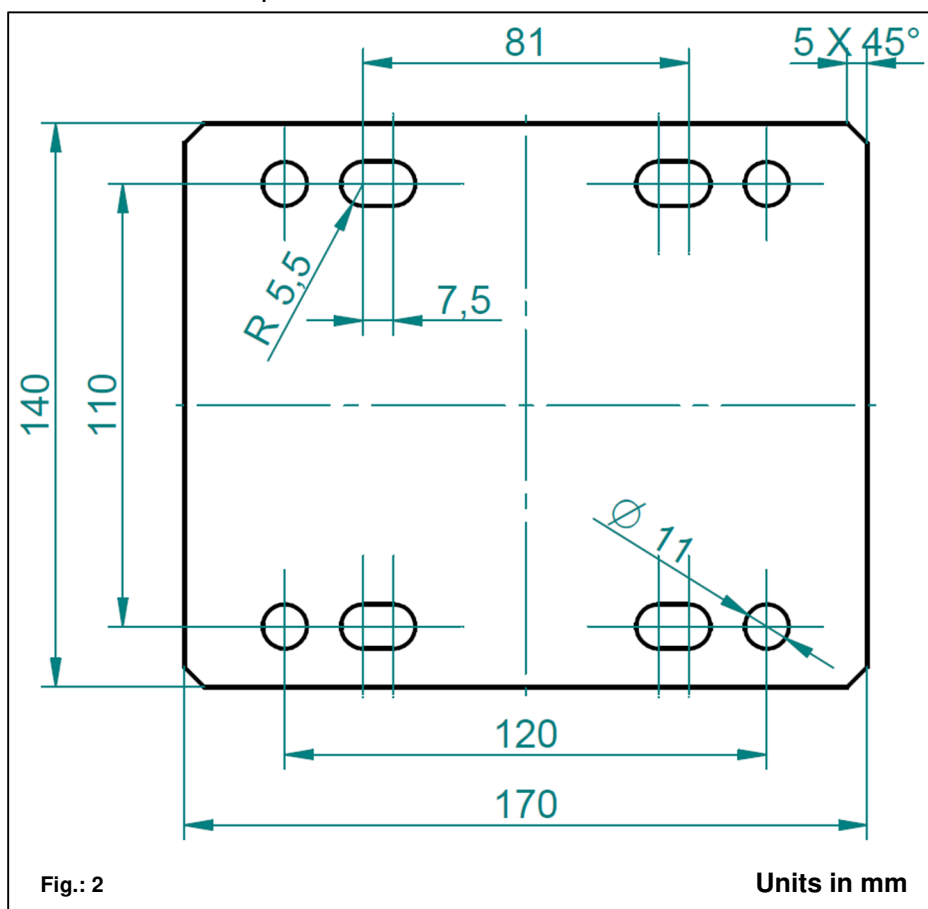

8 Basic information

8.1 Layout and mode of operation

The single disc spreader "ES 100 M1 Classic" is a small seed spreader with a capacity of 105 litres.

The spreading disc is driven by a 12-V electric motor, which is regulated using the controls. The speed of the spreading disc and therefore the working width can be comfortably regulated from the driver's seat using the controls. The power to the control box is supplied directly from the battery.

8.2 Mounting on the tractor



Fig.: 3



Fig.: 4

With the type of mounting shown, you bolt on the tractor linkage drawbar between your ES 100 M1 Classic and the supplied counter plate. You should use bolts with a diameter of 10 mm. Bolt the top link bracket onto the top link plate and fix the top link of your towing vehicle with the pin.

8.3 Mounting on an implement

To mount the ES 100 M1 Classic on an implement, we recommend using the counter plate. Use it to attach your ES 100 M1 Classic on the frame of the mounted implement.

To achieve the maximum working width and also the corresponding distribution, the implement must be mounted at a height of 1.5 metres.



Fig.: 5

8.4 Attachment of the control box

Fasten the standard supplied bracket with two bolts in the tractor cab. Stow the excess cable in the driver's cab to avoid pinching.



TIP: Pay attention to the angle at which you look at the control box to be able to read the display optimally. If necessary, bend the bracket slightly to adjust the angle as required.



Fig.: 6

8.5 Electrical connections

	No.	Meaning
	1	Plug for the module
	2	Positive terminal with line fuse
	3	Negative terminal

The cabling is performed as follows:

- Connect the standard supplied cable directly to the battery. The fuse (20 A) is on the positive terminal of the power cable. For the 2-pin power cable, the cable eyelet is connected to the line fuse (20 A) (no. 2) to the positive terminal, and the other cable eyelet (no. 3) is connected to the negative terminal of the battery.
- Connect the end of the cable with the plug for the module (no. 1) to the control box.
- The 4-pin cable from the control unit is also connected to the control box.



CAUTION: If these instructions are not observed, damage may be caused to the control box!





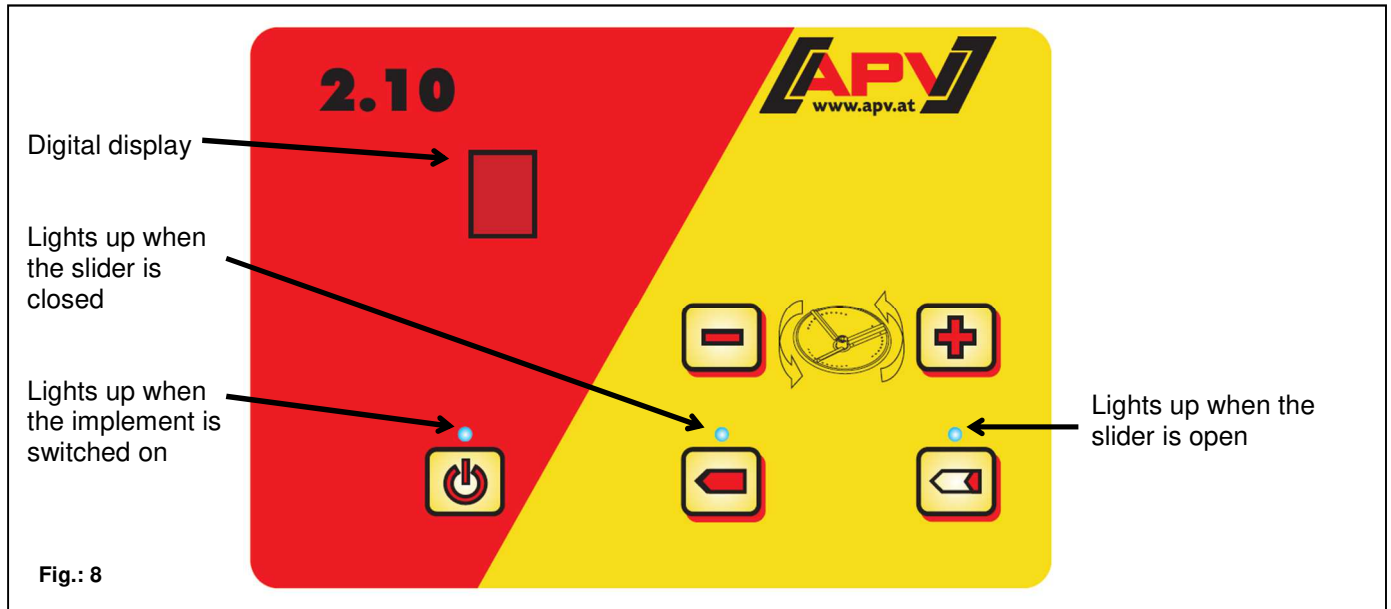

IMPORTANT NOTE: for safety-related reasons, disconnect the controls after using the implement!

8.6 Control box

The ES 100 M1 CLASSIC has a control box with a hermetically sealed keyboard foil. On the bottom side, a 2-pin plug (connection to the battery) and a 4-pin plug (connection of the spreader to the control box) are installed.



Button	Designation	Use
	On/Off button	Switches the implement on or off
	Minus button	Reduces the speed of the spreading disc
	Plus button	Increases the speed of the spreading disc
	Slider closed	Close slider
	Slider open	Open slider

- Press the On/Off button.
 - The controls are switched on and the control lamp above the button lights up.
- Using the plus and minus buttons, set the desired speed for the spreading disc.
- Start driving and open the slider using the "Slider open" button.
 - The control lamp for "Slider open" lights up above the button.
 - The spreading material trickles onto the spreading disc and is distributed accordingly depending on the speed.
- When stopping, press on the "Slider closed" button.
 - The slider is closed and the control lamp for "Slider closed" lights up above the button.
- When leaving the field, switch off the control box using the On/Off button.

8.7 Regulation of the seed rate

Regulating the spread rate:

- The required settings can be found in the corresponding setting chart.
- Loosen the knurled nut and set the metering slider to the required scale position.
Position 0: closed; Position 10: fully open.
- Fix the knurled nut again.



Fig.: 9

8.8 Calibration test

1. Determine the required spread rate using the following formula:

$$\frac{\text{desired spread rate [kg/ha]} \times \text{forward speed [km/h]} \times \text{working width [m]}}{600} = \text{Weight [kg/min]}$$

Example: $\frac{5 \text{ [kg/ha]} \times 12 \text{ [km/h]} \times 12 \text{ [m]}}{600} = 1.2 \text{ [kg/min]}$

2. To perform the calibration test, the transport box or a bag can be used, which is then put on at the front over the spreader. (We offer a calibration bag with scale for this purpose, see 14.6 Calibration bag.)
If you use the box, cut out one of the side walls and put the spreader in it.
3. The required settings can be found in the corresponding setting chart (see Chapter 10 Setting charts).
4. Using the control box, set the approximate speed of the spreading disc that should be used to spread on the field. Pre-select the required scale value for the metering slider. Selection of the correct speed is important because it also affects the calibration quantity.
5. Press and hold the On/Off button of the control box.
6. Press the plus button.
 - The spreading disc is already running at the currently set speed. The slider will be opened for exactly 1 minute.
 - During the calibration process, the set speed will be shown flashing on the digital display.
 - The calibration test will now be performed while the spreading material is collected without losses.

By pressing one of the "Plus", "Minus", "Slider open" or "Slider closed" buttons, the calibration procedure can be stopped.

 - While the calibration procedure is active, the control box **CANNOT** be switched off using the On/Off button.
7. Weigh the calibrated and collected spreading material quantity.
8. Afterwards, the correct value can be determined by changing the scale value at the metering slider and repeating the calibration.
9. Repeat this procedure until you have reached the desired spread rate.
10. After beginning operation, check the spreading on the field. In particular, check the forward speed, the spread rate and distribution across the area.

8.9 Emptying the hopper

To empty the hopper, proceed as follows:

1. Unscrew the screw plug on the emptying nozzle at the front of the hopper and hold a container, bag or other vessel underneath.
2. To ensure complete emptying, hang a bag over the spreading disc.
3. Press and hold the On/Off button of the control box.
4. Press the Minus button.
 - The spreading disc will run at a low speed and the slider will be opened.
 - The emptying process will be shown on the digital display with **9.** (flashing).
5. By pressing one of the "Plus", "Minus", "Slider open" or "Slider closed" buttons, the emptying procedure will be stopped.
While the emptying procedure is active, the control box **CANNOT** be switched off using the On/Off button.

8.10 Removing the hopper

In rare cases, it is necessary to remove the plastic tank for cleaning purposes. To do this, proceed as follows:

- Empty the hopper completely (see Point 8.9 Emptying the hopper).
- Remove the 2 screws that fasten the hopper at the top of the steel rack.
- Remove the hopper and clean it according to Chapter 12 Maintenance and care.
- Put on the hopper.
- Seal the cone again with silicone to prevent the penetration of water.

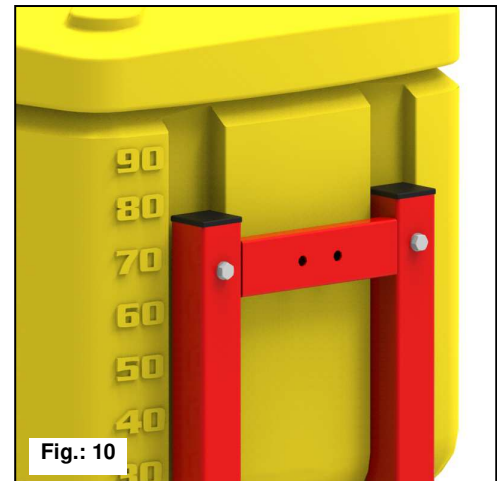

TIP: To remove even the last seed residues, clean out the hopper with compressed air. Alternatively, you can remove the seed residues with an industrial vacuum cleaner.

9 Settings

9.1 Spreading width

The spreading width depends on the density and the shape of the seed as well as the speed of the spreading disc. The single disc spreader is designed such that it can spread seed uniformly over a width of up to 24 m. For this to succeed, the battery and the alternator must be in good condition. The precise settings for the spread rate, working width etc. can be found in the setting chart in Chapter 10.

The spreader must be mounted at least 1.5 m above the ground to achieve optimal spreading density and the maximum working width.



NOTE: When the ES 100 M1 Classic is mounted on implements with small working widths and the seed should be spread directly in/in front of the roller, the spreader can also be slanted slightly downwards. However, it must be noted that the hopper can only be completely emptied when it is in a horizontal position!



TIP: a precision dispersion plate is available as an accessory for such special applications (see 14.5 Precision dispersion plate). This is suitable for small working widths (up to 4 m) and causes the seed to be spread exactly on the roller, for example.

9.2 Agitator

Since driving of the agitator with two dowel pins is generally not necessary, the agitator was only equipped with one agitator pin ex factory. If, however, you should require stronger agitation (e.g. for grass etc.), the following must be performed: The dowel pins supplied as a standard are attached on the bottom agitator pin of the agitator and this increases the efficacy of the agitator. If necessary, the top agitator pin, which is enclosed with the dowel pins in a pressure lock bag, can be attached in the intended opening on the agitator. As a result, the flow of spreading material is ensured, which is either very light (grasses etc.) or also tends to form bridges (seed that is not quite dry, etc.).

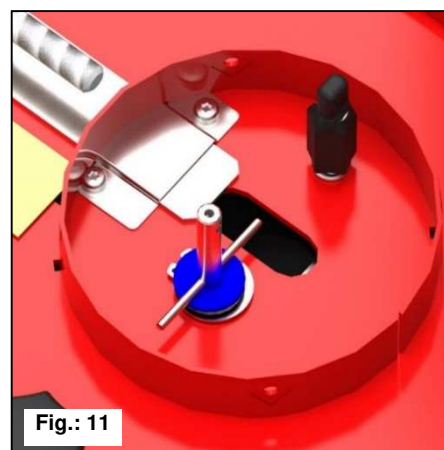
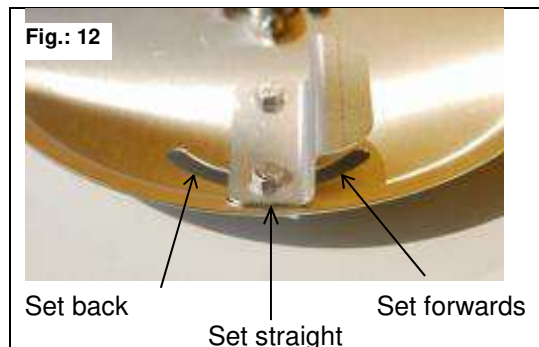

Fig.: 11

9.3 Spreading disc, lateral distribution, throwing vanes

The spreading disc must rotate counterclockwise. With the throwing vanes attached to the spreading disc, the spreading pattern can be adapted to the specific weight (density) of the spreading material. This results in uniform lateral distribution. If the lateral distribution is not optimal, for some spreading widths and materials the throwing vanes should be adjusted according to the following aspects:



TIP: When the throwing vanes are moved forward, the spreading material exits the disc a little later and the implement spreads a little more to the right (when standing in front of the spreader). When the throwing vanes are moved back, the spreading material exits the disc a little earlier and the implement spreads a little more to the left.

If you have decided to use a precision dispersion plate (accessory), install it at the front on the ES 100 M1 Classic. This is suitable for small working widths (up to 4 m) and causes the seed to be spread exactly on the roller, for example.



NOTE: The slider is only opened when the spreading plate is rotating!

9.4 Deflectors (guide plate)

For normal spreading widths and spread rates, these deflectors are not required. With the supplied deflectors, which are attached either to the right or left behind the spreading disc on the thread intended for this purpose, you can influence the spreading cone so that it is optimally adapted for your area of application.





Two application examples:

- When you want to spread on one side, put the longer deflector on one side of the spreader. Screw it on with the 6mm wing nut on the thread installed behind the spreading disc.
- You have installed the spreader on a cultivator or a similar implement. You observe the spreading cone and see that there is more overlap on one side of the implement than on the other. Then take one of the shorter deflectors and use it to limit the side with more overlap.

10 Setting charts

These tables can be used as reference values. However, they cannot be used in the same way everywhere as many factors play a role or strong changes can occur (such as thousand grain weight, seed moisture content, changes in flow behaviour, and much more).

Grass Grass Herbe Lolium perenne (with dowel pins mounted at the bottom)												
Working width	2.5 m				4.0 m				6.0 m			
Speed	2 – 3				3 – 5				8 – 9			
Forward speed km/h	6	8	10	12	6	8	10	12	6	8	10	12
Slider opening												
15 kg/ha	4.8	5.1	5.7	5.9	3.9	4.3	5.2	5.5	3.8	4.0	4.5	5.5
25 kg/ha	5.2	5.5	7.0	8.2	5.0	5.3	6.6	7.2	6.0	7.5	8.2	9.0

White clover White clover Trèfle Blanc Trifolium repens												
Working width	3.0 m				6.0 m				12.0 m			
Speed	2				3				8			
Forward speed km/h	6	8	10	12	6	8	10	12	6	8	10	12
Slider opening												
10 kg/ha	1.0	1.2	1.4	1.6	1.3	1.5	1.8	2.0	1.6	1.9	2.1	2.3

Phacelia
Phacelia
Phacélie

Phacelia tanacetifolia



Working width	3.0 m				6.0 m				10.0 m			
Speed	2 – 3				4				9 – 9			
Forward speed km/h	6	8	10	12	6	8	10	12	6	8	10	12
Slider opening												
10 kg/ha	2.0	2.3	2.6	2.9	2.8	3.0	3.6	4.5	3.0	3.2	3.8	5.0

White mustard
Mustard
Moutarde

Sinapis Alba



Working width	3.0 m				6.0 m				15.0 m			
Speed	1 – 2				4				8 – 9			
Forward speed km/h	6	8	10	12	6	8	10	12	6	8	10	12
Slider opening												
15 kg/ha	1.6	1.9	2.1	2.3	2.0	2.3	2.5	3.0	2.8	3.5	4.5	6.0
25 kg/ha	2.2	2.6	3.2	3.4	3.0	3.3	4.0	5.5	4.0	4.8	6.5	8.5

Buckwheat
Buckwheat
Blé Noir

Fagopyrum



Working width	3.0 m			
Speed	2.			
Forward speed km/h	4	6	8	10
Slider opening				
50 kg/ha	6.0	7.0	8.0	9.5
80 kg/ha	7.0	9.0	10.0	

Vetch
Vetch
Vesce

Vicia



Working width	3.0 m				6.0 m				9.0 m			
Speed	2				4				6			
Forward speed km/h	6	8	10	12	6	8	10	12	6	8	10	12
Slider opening												
10 kg/ha	2.5	3.0	3.2	3.6	2.7	3.0	3.3	3.7	2.8	3.1	3.9	4.1
20 kg/ha	3.5	3.8	4.0	4.2	3.7	4.0	4.5	5.2	4.2	4.8	6.0	6.5
Throwing vane settings	1 normal 1 half forward				both normal				both normal			

**Lucerne
Alfalfa
Lucerne**

Medicago Sativa



Working width	3.0 m				6.0 m				9.0 m			
Speed	2				4				8			
Forward speed km/h	6	8	10	12	6	8	10	12	6	8	10	12
Slider opening												
10 kg/ha	1.5	1.7	1.8	2.0	1.2	1.8	2.0	2.3	2.0	2.2	2.8	3.0
20 kg/ha	2.0	2.5	2.7	2.9	2.5	3.0	3.6	3.6	3.0	3.3	3.9	4.3
Throwing vane settings	both half forward				1 normal 1 all the way forward				1 normal 1 all the way forward			

**Red clover
Red clover
Trèfle Rouge**

Trifolium



Working width	3.0 m				6.0 m				9.0 m			
Speed	2				5 – 6				8 – 9			
Forward speed km/h	6	8	10	12	6	8	10	12	6	8	10	12
Slider opening												
15 kg/ha	2.8	3.3	3.5	4.0	1.6	1.8	2.0	3.5	1.9	2.5	2.9	3.5
20 kg/ha	3.3	3.8	4.2	4.5	1.8	2.2	2.8	3.5	2.5	3.2	3.6	4.0

Schneckenlinsen Slug lentils Lentilles anti-limaces												
	Working width	12.0 m			15.0 m			18.0 m			20.0 m	
Speed	5 – 6			7 – 8			8 – 9			9 – 9		
Forward speed km/h	10	15	20	10	15	20	10	15	20	10	15	20
Slider opening												
3 kg/ha	2.2	2.8	3.0	2.2	3.0	3.3	2.3	2.7	3.0	2.2	2.7	3.2

Metarex INOV Metarex INO Metarex TDS Slug pellets Metarex grains anti-limaces												
	Working width	12.0 m			15.0 m			20.0 m			24.0 m	
Speed	5 – 6			7 – 8			8 – 9			9 – 9		
Forward speed km/h	10	15	20	10	15	20	10	15	20	10	15	20
Slider opening												
5 kg/ha	3.2	3.8	4.5	3.3	3.8	4.3	3.5	4.2	4.9	3.5	4.5	5.5

Allowin/Allowin Quattro												
	Working width	12.0 m			15.0 m			20.0 m			24.0 m	
Speed	5 – 6			7 – 8			8 – 9			9 – 9		
Forward speed km/h	10	15	20	10	15	20	10	15	20	10	15	20
Slider opening												
5 kg/ha	3.4	3.9	4.5	3.2	3.6	4.5	3.3	4.1	4.8	3.6	4.5	5.5

**Clartex Neo
Slug-off**

Working width	12.0 m			15.0 m			20.0 m			24.0 m		
Speed	5 – 6			7 – 8			8 – 9			9 – 9		
Forward speed km/h	10	15	20	10	15	20	10	15	20	10	15	20
Slider opening												
5 kg/ha	2.5	4	4.5	3.2	3.8	4.2	3.5	4.1	4.9	3.7	4.5	5.5



TIP: It can be sensible to check the settings for the spread rate from time to time. With large working widths, the wind velocity should be observed to prevent spreading errors.



NOTE: The slider is only opened when the spreading plate is rotating!
The maximum working width depends on the battery voltage too!

11 Error messages

The error message codes were created to monitor proper operation of the implement and to inform the user if proper operating of the implement is no longer possible.

Problem	Cause	Possible remedy
"b" Battery error flashes on the display.	The operating voltage is too low or fluctuates too much	Check the on-board electronics and the battery.
The slider will be closed and the motor switched off. The implement cannot be operated.	CAUTION: if your battery is charged by a charger that is in "Start" operating mode, this may lead to voltage peaks! This can cause damage to the implement!	Disconnect the charger, check the on-board electronics and the battery.
"E" Error flashes on the display.	Motor cable break	Check the cable routing and the motion of the spreading disc.
	Motor blocked (=stiff)	Check the cable routing and the motion of the spreading disc.

12 Maintenance and care

12.1 General information

To maintain the implement in good condition even after a long service life, the following instructions must be observed:

- Original parts and accessories are designed especially for the machines or implements.
- Please note that spare parts and accessories not supplied by us have also not been tested and approved by us.
- The installation or use of such products can therefore possibly negatively change or impede the constructional properties of your implement. The manufacturer rules out any liability for damages resulting from the use of non-original parts and accessories.
- The manufacturer is not liable for any unauthorised modifications and the use of components and auxiliary parts.
- All bolted connections should be re-tightened at the latest after 3 operating hours and again after 20 hours, and then checked regularly. (Loose bolts can cause significant consequential damage, which is not covered by the warranty.)
- Do not clean the implement with water. Clean the implement with compressed air, however, make sure that the pressure is not too high. The paint can be damaged by cleaning with excessive pressure.
- Park the implement protected from weather conditions.
- During the winter, the implement should be protected against rust with an environmentally-friendly product.

13 Storage and disposal

To ensure that the spreader remains fully functional even if it is out of operation for longer periods of time, it is important to take precautions for storage.

This is how to prepare the spreader for storage:

1. Completely remove all seed from the spreader.
2. Clean the spreader inside and out.
3. Store the spreader in a dry place to prevent the formation of germs inside the implement.

The spreader must be stored in a dry place protected from weather conditions to ensure that it remains functional even if it is stored for a longer period of time.

Disposal of the spreader must be performed according to the local disposal regulations for machines.

14 Accessories

14.1 Cable extension 5 m (4-pin)

This cable extension is required when the soil tillage implement is longer than the 6 m cable installed ex factory, or to allow practical routing of the cable.

Items included: 1 cable extension
Order number: Item no.: 00410-2-035



14.2 Pick-up mounting bracket

For practical and easy attachment to flatbeds or pick-up trucks.

Items included: 1 pick-up mounting bracket
Order number: Item no.: 00300-1-001

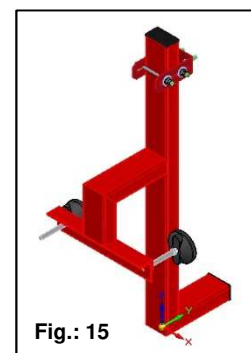

14.3 Quad (ATV) bracket

To mount your ES 100 M1 Classic on an ATV or quad bike, we offer a quad bracket as an accessory.

Items included: 1 quad bracket
Order number: Item no.: 00300-2-135

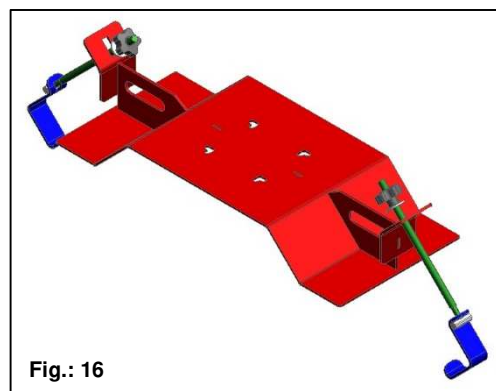

14.4 Height-adjustable quad bracket

To mount the ES 100 M1 Classic on a quad bike/ATV.

Items included: 1 height-adjustable quad bracket
Order number: Item no.: 00300-2-022

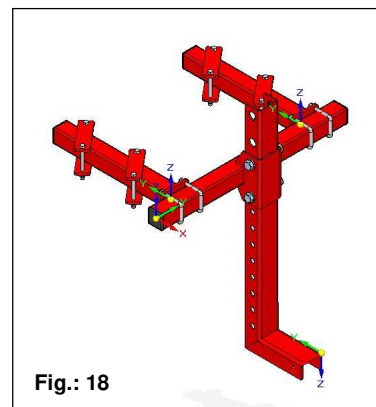

Fig.: 18

14.5 Precision dispersion plate

If you would like to use your ES 100 M1 Classic for small working widths, you can also purchase a precision dispersion plate. It was specially developed for small working widths (up to approx. 4 m) and causes the seed to be spread precisely in the roller (or in front of it).

Items included: 1 precision dispersion plate
Order number: Item no.: 02001-1-103

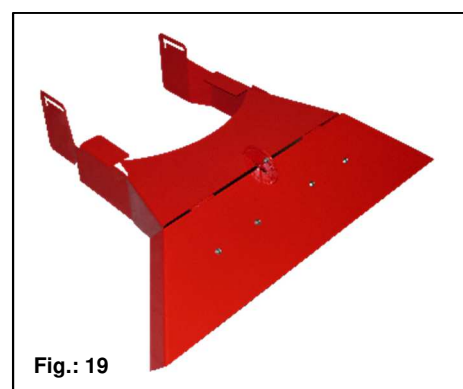

Fig.: 19

14.6 Calibration bag

A calibration bag is available as an accessory to enable precise calibration.

Items included: 1 calibration bag + scale
Order number: Item no.: 02000-2-004



Fig.: 20



PLEASE NOTE: Misprints, errors and omissions excepted!

15 My idea

The **ES 100 M1 Classic** was extensively developed and tested. It took a long time from the initial idea to serial production. It required lots of commitment from the entire development team.

Nonetheless, the most valuable experience is gained in practice. Our motto:

"Inspired by Farmers & realized by Professionals."

This is how customer proximity of the development department creates a leading edge for you and APV.

Tell us about the positive and negative experiences you have had with the implement.

Share your suggestions for improvement and your ideas with us:

meineidee@apv.at

Take pictures or make hand-drawn sketches! We are open and grateful for any information, no matter in what form. Your information goes directly to the leading developers at APV.

I would like to thank you in advance for your involvement and wish you lots of fun with your APV product!

Sincerely yours,

Your Head of Development & Technology

16 Index

Accessories	26	Maintenance and care	25
Accident prevention and safety instructions.....	6	Metarex.....	23
Agitator	17	Motor	24
Allowin	23	Mounted implements	8
Attachment of the control box	13	Mounting on an implement.....	12
Battery	24	Mounting on the tractor	12
Battery error.....	24	On/Off button	14
Buckwheat.....	21	On-board electronics	24
Cable extension.....	26	Phacelia.....	20
Cabing	13	Pick-up mounting bracket	26
Calibration bag	27	Precision dispersion plate.....	17, 18, 27
Calibration procedure	15	Quad (ATV) bracket.....	26
Calibration test.....	15	Red clover.....	22
Clartex	24	Removing the hopper	16
Control box	14	Safety signs	10
Control lamp	14	Schneckenlinsen.....	23
Counter plate	11, 12	Service.....	5
Declaration of Conformity	4	Setting charts.....	19
Deflectors	18	Settings.....	17
Directive.....	4	Slider	14
Disposal.....	25	Spare parts orders	5
Electrical connections.....	13	Speed	15
Emptying.....	16	Speed of the spreading disc	14
Error	24	Spreading disc	18
Error message	24	Spreading width	17
Grass	19	Standards	4
Guide plates	18	Storage	25
Height-adjustable quad bracket.....	27	Technical data	11
Identification	5	Throwing vanes	18
Intended use.....	6	type plate	5
Lateral distribution	18	Vetch	21
Layout and mode of operation	12	Warranty	6
Lucerne.....	22	White clover	19
Maintenance	9	White mustard.....	20

Notes

A large rectangular area filled with a fine grid pattern, intended for writing notes. The grid consists of small squares and covers most of the page's content area.

Notes

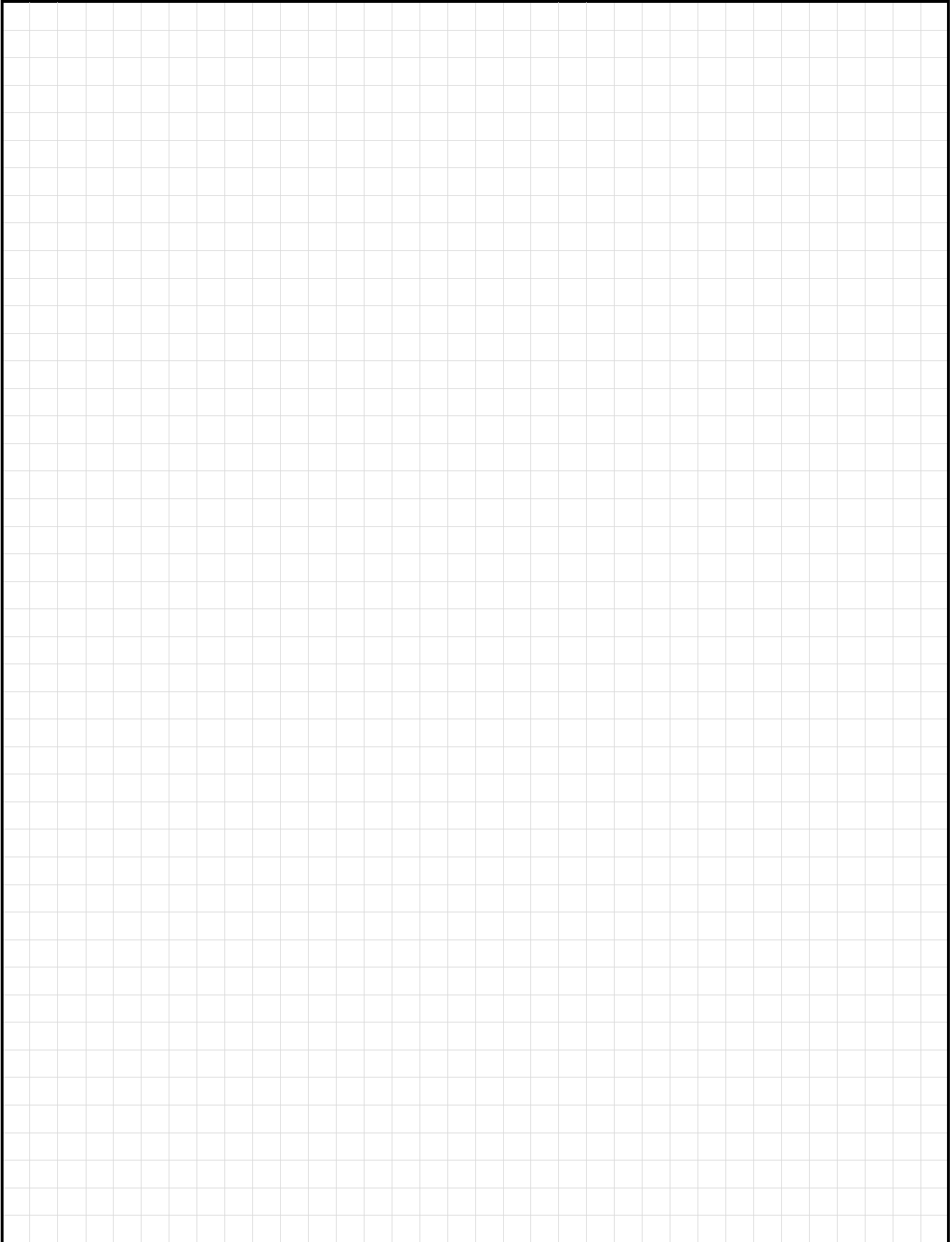
A large rectangular area filled with a fine grid pattern, intended for taking notes. The grid consists of small squares and occupies most of the page below the 'Notes' header.

Quality for Professionals

Inspired by Farmers & realized by Professionals



**APV - Technische Produkte GmbH
HEADQUARTERS
Dallein 15
AT - 3753 Hötzelstdorf**

**Tel.: +43 / (0)2913 / 8001
Fax: +43 / (0)2913 / 8002**

**www.apv.at
office@apv.at**